

User's manual

FLIR DM93

True RMS Industrial Multimeter

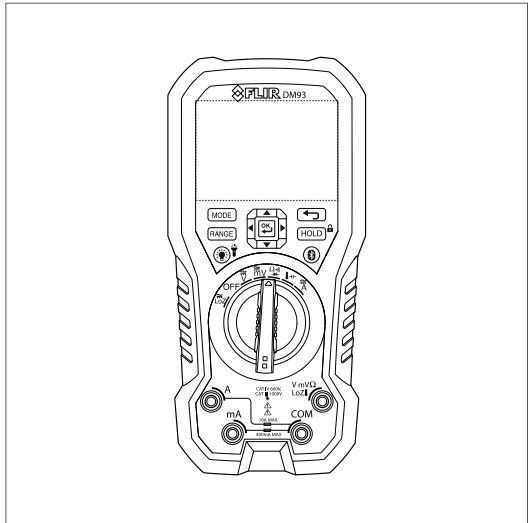



User's manual
FLIR DM93



Table of contents

| | | |
|----------|--|-----------|
| 1 | Disclaimers | 1 |
| | 1.1 Copyright..... | 1 |
| | 1.2 Quality assurance | 1 |
| | 1.3 Documentation updates..... | 1 |
| | 1.4 Disposal of electronic waste..... | 1 |
| 2 | Safety information | 2 |
| | 2.1 FCC Compliance | 5 |
| | 2.2 Industry Canada compliance..... | 6 |
| 3 | Introduction | 7 |
| | 3.1 Key features..... | 7 |
| 4 | Description | 8 |
| | 4.1 Meter description | 8 |
| | 4.2 Function switch | 9 |
| | 4.3 Function buttons | 10 |
| | 4.4 Display description | 11 |
| | 4.5 Display icons and indicators | 11 |
| 5 | Operation | 14 |
| | 5.1 Powering the meter | 14 |
| | 5.2 Auto/Manual select mode | 14 |
| | 5.3 Auto/Manual range mode | 15 |
| | 5.4 Voltage measurements | 15 |
| | 5.5 Resistance measurements | 16 |
| | 5.6 Continuity test..... | 16 |
| | 5.7 Diode test | 17 |
| | 5.8 Capacitance measurements | 18 |
| | 5.9 Type K temperature measurements..... | 18 |
| | 5.10 Current measurements | 19 |
| | 5.11 Extended functionality | 19 |
| | 5.12 Normal hold mode and Auto hold mode | 24 |
| | 5.13 Locked mode | 25 |
| | 5.14 Streaming measurement data using Bluetooth..... | 25 |
| 6 | Maintenance | 26 |
| | 6.1 Cleaning and storage..... | 26 |
| | 6.2 Battery replacement | 26 |

Table of contents

| | | |
|----------|---|-----------|
| 6.3 | Fuse replacement | 26 |
| 6.4 | Disposal of electronic waste..... | 26 |
| 7 | Technical specifications | 27 |
| 7.1 | General specifications | 27 |
| 7.2 | Electrical specifications | 28 |
| 8 | Technical support | 35 |
| 9 | Warranties | 36 |
| 9.1 | FLIR Global Limited Lifetime Warranty | 36 |
| 9.2 | FLIR Test and Measurement Limited 2 Year Warranty..... | 37 |

1 Disclaimers

1.1 Copyright

© 2013, FLIR Systems, Inc. All rights reserved worldwide. No parts of the software including source code may be reproduced, transmitted, transcribed or translated into any language or computer language in any form or by any means, electronic, magnetic, optical, manual or otherwise, without the prior written permission of FLIR Systems.

The documentation must not, in whole or part, be copied, photocopied, reproduced, translated or transmitted to any electronic medium or machine readable form without prior consent, in writing, from FLIR Systems.

Names and marks appearing on the products herein are either registered trademarks or trademarks of FLIR Systems and/or its subsidiaries. All other trademarks, trade names or company names referenced herein are used for identification only and are the property of their respective owners.

1.2 Quality assurance

The Quality Management System under which these products are developed and manufactured has been certified in accordance with the ISO 9001 standard.

FLIR Systems is committed to a policy of continuous development; therefore we reserve the right to make changes and improvements on any of the products without prior notice.

1.3 Documentation updates

Our manuals are updated several times per year, and we also issue product-critical notifications of changes on a regular basis.

To access the latest manuals and notifications, go to the Download tab at:

<http://support.flir.com>

It only takes a few minutes to register online. In the download area you will also find the latest releases of manuals for our other products, as well as manuals for our historical and obsolete products.

1.4 Disposal of electronic waste



As with most electronic products, this equipment must be disposed of in an environmentally friendly way, and in accordance with existing regulations for electronic waste.

Please contact your FLIR Systems representative for more details.

2 Safety information

Note

Before operating the device, you must read, understand, and follow all instructions, dangers, warnings, cautions, and notes.

Note

FLIR Systems reserves the right to discontinue models, parts or accessories, and other items, or to change specifications at any time without prior notice.

Note

Remove the batteries if the device is not used for an extended period of time.



WARNING

Do not operate the device if you do not have the correct knowledge. Formal qualifications and/or national legislation for the electrical inspections can apply. Incorrect operation of the device can cause damage, shock, injury or death to persons.



WARNING

Do not start the measuring procedure before you have set the function switch to the correct position. This can cause damage to the instrument and can cause injury to persons.



WARNING

Do not change to current or resistance when you measure the voltage. This can cause damage to the instrument and can cause injury to persons.

2 Safety information



WARNING

Do not measure the current on a circuit when the voltage increases to more than 1000 V. This can cause damage to the instrument and can cause injury to persons.



WARNING

You must disconnect the test leads from the circuit that you did a test on before you change the range. If you do not do this, damage to the instrument and injury to persons can occur.



WARNING

Do not replace the batteries or the fuses before you remove the test leads. This can cause damage to the instrument and can cause injury to persons.



WARNING

Do not use the device if the test leads and/or the device show signs of damage. Injury to persons can occur.



WARNING

Be careful when you do the measurements if the voltages are more than 25 VAC rms or 35 VDC. There is a risk of shock from these voltages. Injury to persons can occur.



WARNING

Do not do diode, resistance or continuity tests before you have removed the power from capacitors and other devices under test during a measurement. Injury to persons can occur.

2 Safety information



WARNING

Do not use the device as a tool to identify live terminals. You must use the correct tools. Injury to persons can occur if you do not use the correct tools.



WARNING

Make sure that children cannot touch the device. The device contains dangerous objects and small parts that children can swallow. If a child swallows an object or a part, speak with a physician immediately. Injury to persons can occur.



WARNING

Do not let children play with the batteries and/or the packing material. These can be dangerous for children if they use them as toys.



WARNING

Do not touch expired or damaged batteries without gloves. Injury to persons can occur.



WARNING

Do not cause a short-circuit of the batteries. This can cause damage to the instrument and can cause injury to persons.



WARNING



Do not put the batteries into a fire. Injury to persons can occur.



CAUTION

Do not use the device for a procedure that it is not made for. This can cause damage to the protection.

2 Safety information

| | |
|---|--|
|  | This symbol, adjacent to another symbol or terminal, indicates that the user must refer to the manual for further information. |
|  | This symbol, adjacent to a terminal, indicates that, under normal use, hazardous voltages may be present. |
|  | Double insulation. |



UL listing is not an indication or a verification of the accuracy of the meter

2.1 FCC Compliance

This device complies with part 15 of the FCC Rules. Operation is subject to the following two conditions:

1. This device may not cause harmful interference.
2. This device must accept any interference received, including interference that may cause undesired operation.

This equipment has been tested and found to comply with the limits for a Class B digital device, pursuant to part 15 of the FCC Rules. These limits are designed to provide reasonable protection against harmful interference in a residential installation. This equipment generates, uses, and can radiate radio frequency energy and, if not installed and used in accordance with the instructions, may cause harmful interference to radio communications. However, there is no guarantee that interference will not occur in a particular installation. If this equipment does cause harmful interference to radio or television reception, which can be determined by turning the equipment off and on, the user is encouraged to try to correct the interference by one or more of the following measures:

- Reorient or relocate the receiving antenna.
- Increase the separation between the equipment and receiver.
- Connect the equipment into an outlet on a circuit different from that to which the receiver is connected.
- Consult the dealer or an experienced radio/TV technician for help.

2 Safety information



CAUTION

Exposure to Radio Frequency Radiation.

To comply with FCC/IC RF exposure compliance requirements, a separation distance of at least 20 cm must be maintained between the antenna of this device and all persons. This device must not be co-located or operating in conjunction with any other antenna or transmitter.



WARNING

Changes or modifications not expressly approved by the party responsible for compliance could void the user's authority to operate the equipment.

2.2 Industry Canada compliance

This device complies with Industry Canada licence-exempt RSS standard(s). Operation is subject to the following two conditions: (1) this device may not cause interference, and (2) this device must accept any interference, including interference that may cause undesired operation of the device.



CAUTION

Exposure to Radio Frequency Radiation.

To comply with RSS 102 RF exposure compliance requirements, for mobile configurations, a separation distance of at least 20 cm must be maintained between the antenna of this device and all persons. This device must not be co-located or operating in conjunction with any other antenna or transmitter.

3 Introduction

Thank you for choosing a FLIR DM93 digital multimeter.

This device is shipped fully tested and calibrated and, with proper use, will provide years of reliable service.

3.1 Key features

- 4000/40 000 counts extra-large digital dual display.
- Auto selection AC/DC in voltage and current modes.
- On-screen menu selection and navigator key drive.
- Variable-frequency drive mode (low-pass filter).
- 0.05% DCV accuracy.
- Low-Z measurement.
- Auto hold.
- Peak hold measurement.
- dB/dBm measurement.
- 20,000-record automatic data recording capacity.
- 99-record manual data record/recall memory.
- Indoor use only; 2000 m (6561').
- Bluetooth interface with software included.
- Safety Category Rating: CAT IV-600V, CAT III-1000V.

4 Description

4.1 Meter description

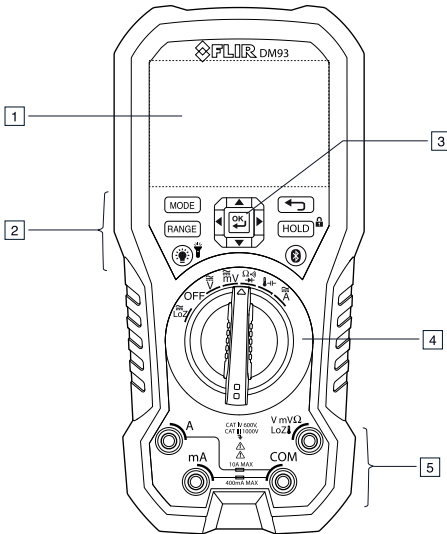

Figure 4.1 Front view

1. LCD display.
2. Function buttons, see section 4.3 *Function buttons*, page 10.
3. Selector pad.
4. Function switch, see section 4.2 *Function switch*, page 9.
5. Probe input terminals.

4 Description

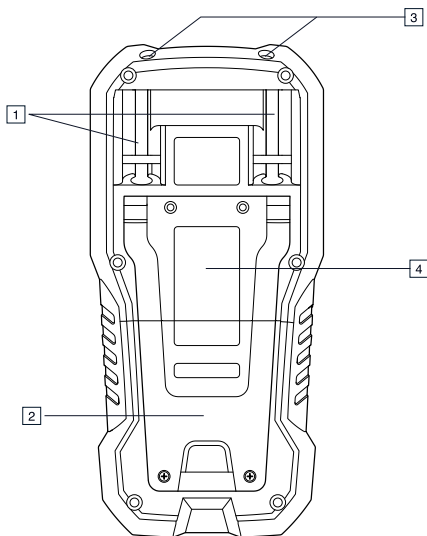





Figure 4.2 Rear view

1. Probe clips.
2. Tilt stand.
3. Work light.
4. Battery compartment cover.





4.2 Function switch

| | |
|-----------------|--|
| LoZ | The meter can measure voltage through the probe inputs. A low-impedance load is placed across the inputs to stabilize the measurement. |
| OFF | The meter is in full power-saving mode. |
| \approx V | The meter can measure high voltage (V) through the probe inputs. |
| \approx mV | The meter can measure low voltage (mV) through the probe inputs. |



4 Description

| | |
|---|--|
|  | The meter can measure resistance, continuity, or diode polarity through the probe inputs. The type of measurement is selected by the MODE button. |
|  | The meter can measure capacitance through the probe inputs or temperature through a thermocouple adapter. The type of measurement is selected by the MODE button. |
|  | The meter can measure current through the probe inputs. |

4.3 Function buttons

| | |
|---|---|
|  | <ul style="list-style-type: none">• Use the button to select Auto select or Manual select mode, see section 5.2 <i>Auto/Manual select mode</i>, page 14.• In Manual select mode, press the button to change the operating mode. |
|  | <ul style="list-style-type: none">• Use the button to select Auto range or Manual range mode, see section 5.3 <i>Auto/Manual range mode</i>, page 15.• In Manual range mode, press the button to change the range (scale). |
|  | <ul style="list-style-type: none">• Press the button to toggle between Normal and Hold mode, see section 5.12 <i>Normal hold mode and Auto hold mode</i>, page 24.• Press and hold the button for 5 seconds to enable/disable Locked mode, see section 5.13 <i>Locked mode</i>, page 25. |
|  | Use the selector pad to enable extended functionality modes and to navigate in mode options. |
|  | Press the button to exit an extended functionality mode. |

4 Description





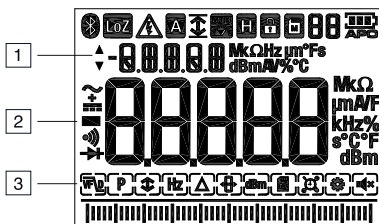

| | |
|---|--|
|  | <ul style="list-style-type: none"> • Press the button to enable/disable the display backlight. • Press and hold the button for 2 seconds to enable/disable the work light. |
|  | <p>Press the button to enable/disable METERLiNK® (Bluetooth) communication, see section 5.14 <i>Streaming measurement data using Bluetooth</i>, page 25.</p> |

4.4 Display description























1. Secondary display.
2. Main display.
3. Bar graph (matches the reading on the main display).



4.5 Display icons and indicators

| | |
|---|--|
| LoZ | Indicates that the meter is measuring stabilized voltage. |
|  | Indicates that the measured voltage is greater than 30 V (AC or DC). |
|  | Indicates that the Auto select mode is active. |
|  | Indicates that the meter is displaying maximum reading values. |
|  | Indicates that the meter is displaying minimum reading values. |
|  | Indicates that the meter is displaying the average reading. |
|  | Indicates that the meter is displaying peak maximum values. |

4 Description

| | |
|---|---|
|  | Indicates that the meter is displaying peak minimum values. |
|  | Indicates that the meter is in Auto range mode. |
|  | Indicates that the meter is in Hold mode. |
|  | Indicates that the meter is in Locked mode. |
|  | Indicates the active memory location (1–99). |
|  | Indicates the battery voltage status. |
|  | Indicates that the auto power off function is enabled. |
|  | Indicates that the meter is measuring AC current or voltage. |
|  | Indicates that the meter is measuring DC current or voltage. |
|  | Indicates that the meter is measuring AC+DC current or voltage. |
|  | Indicates that the continuity function is active. |
|  | Indicates that the diode test function is active. |
|  | VFD mode icon. |
|  | Peak mode icon. |
|  | Min/Max/Avg mode icon. |
|  | Frequency mode icon. |
|  | Relative mode icon. |
|  | 4000/40 000 digit selection. |
|  | dBm mode icon. |
|  | 99-point Manual Data Recording mode icon. |

4 Description

| | |
|---|---|
|  | 20,000 point Automatic Data Recording (Sampling) mode icon. |
|  | Setup mode icon. |
|  | Silent mode icon. |

4.5.1 Probe indicator

When the probe leads are not plugged into the correct jack sockets for the measurement selected by the function switch, *PROBE* is displayed.

4.5.2 Out-of-range warning

If the input is over/under the full-scale range in Manual range mode, or if the signal has exceeded the maximum/minimum input in Auto range mode, *OL* is displayed.

5 Operation

Note

Before operating the device, you must read, understand, and follow all instructions, dangers, warnings, cautions, and notes.

Note

When the meter is not in use, the function switch should be set to the OFF position.

Note

When connecting the probe leads to the device under test, connect the negative lead before connecting the positive lead. When removing the probe leads, remove the positive lead before removing the negative lead.

5.1 Powering the meter

1. Set the function switch to any position to switch on the meter.
2. If the battery indicator  shows that the battery voltage is low or if the meter does not power on, replace the battery. See section 6.2 *Battery replacement*, page 26.

5.1.1 Auto power off

The meter enters sleep mode after a programmable number of minutes of inactivity, see section 5.11.10 *Setup mode*, page 23.

The meter beeps three times 10 seconds before powering off. Press any button or turn the function switch to prevent the meter from powering off. The auto power off time-out is then reset.

5.2 Auto/Manual select mode

In Auto select mode, the meter attempts to automatically select the proper operating mode based on the input signal:

If the function switch is set to the LoZ, \tilde{V} , $\approx mV$, or \tilde{A} position, the meter attempts to determine if the AC or DC mode should be used.

5 Operation

Auto select mode is the default mode of operation. When a new function is selected with the function switch, the starting mode is Auto select and the **A** indicator is displayed.

To enter Manual select mode, press the **MODE** button. To manually select the operating mode, press the **MODE** button repeatedly.

To enter Auto select mode, press and hold the **MODE** button until the **A** indicator is displayed.

5.3 Auto/Manual range mode

In Auto range mode, the meter automatically selects the most appropriate measurement scale. In Manual range mode, the desired range (scale) is set manually.

Auto range mode is the default mode of operation. When a new function is selected with the function switch, the starting mode is Auto range and the **AUTO** indicator is displayed.

To enter Manual range mode, press the **RANGE** button. To change the range, press the **RANGE** button repeatedly until the desired range is displayed.

To enter Auto range mode, press and hold the **RANGE** button until the **AUTO** indicator is displayed.

5.4 Voltage measurements

1. Set the function switch to one of the following positions:

- \overline{V} for high voltage measurements.
- \overline{mV} for low voltage measurements.
- LoZ for voltage measurements using the meter's low input impedance mode. The LoZ indicator is displayed.

2. Insert the black probe lead into the negative COM terminal and the red probe lead into the positive $\overline{V_{mV\Omega}}$ \overline{LoZ} terminal.

5 Operation

- Use the **MODE** button to select AC, DC, or AC+DC voltage measurement.
 - The \sim indicator will be displayed for AC measurements.
 - The \equiv indicator will be displayed for DC measurements.
 - The \sim indicator will be displayed for AC+DC measurements.
- Connect the probe leads in parallel to the part under test.
- Read the voltage value on the display.

5.5 Resistance measurements



WARNING

Do not do diode, resistance or continuity tests before you have removed the power from capacitors and other devices under test during a measurement. Injury to persons can occur.

- Set the function switch to the Ω position.
- Ensure that the meter is set to resistance measurement. The Ω unit will be displayed.

If the Ω or \rightarrow indicator is displayed, press the **MODE** button repeatedly until the Ω unit is displayed.

- Insert the black probe lead into the negative COM terminal and the red probe lead into the positive $V_{mV}\Omega$ terminal.
- Touch the tips of the probe across the circuit or component under test.
- Read the resistance value on the display.

5.6 Continuity test



WARNING

Do not do diode, resistance or continuity tests before you have removed the power from capacitors and other devices under test during a measurement. Injury to persons can occur.

- Set the function switch to the Ω position.

5 Operation

- Use the **MODE** button to select continuity measurement. The Ω indicator will be displayed.
- Insert the black probe lead into the negative COM terminal and the red probe lead into the positive $V_{mV\Omega}$ terminal.
- Touch the tips of the probe across the circuit or component under test.
- If the resistance is $30 \pm 5 \Omega$ (nominal) or less, the meter beeps.

Note

This threshold is user selectable in the *SET UP* menu under the *Cntin* setting:

- Range: 10–50 Ω .
- Increment: 1.
- Default: 30 Ω .

5.7 Diode test



WARNING

Do not do diode, resistance or continuity tests before you have removed the power from capacitors and other devices under test during a measurement. Injury to persons can occur.

- Set the function switch to the Ω position.
- Use the **MODE** button to select the diode test function. The \rightarrow indicator will be displayed.
- Insert the black probe lead into the negative COM terminal and the red probe lead into the positive $V_{mV\Omega}$ terminal.
- Touch the tips of the probe across the diode or semiconductor junction under test. Make a note of the value on the display.
- Reverse the polarity of the probes, by interchanging the probe test locations.
- Touch the tips of the probe across the diode or semiconductor junction under test. Make a note of the new value on the display.

5 Operation

- The diode or semiconductor junction can be evaluated as follows:
 - If one of the readings displays a value (typically 0.400 V or 0.900 V) and the other reading displays *OL*, the component is good.
 - If both readings display *OL*, the component is open.
 - If both readings are very small or 0, the component is shorted.

5.8 Capacitance measurements



WARNING

Do not take capacitance measurements before you have removed the power from the capacitor or other device or circuit during a test. Injury to persons can occur.

- Set the function switch to the $\text{V}_{\text{mV}\Omega}$ position.
- Use the **MODE** button to select capacitance measurement. The F (Farad) unit will be displayed.
- Insert the black probe lead into the negative COM terminal and the red probe lead into the positive $\text{V}_{\text{mV}\Omega}$ terminal.
- Touch the tips of the probe across the part under test.
- Read the capacitance value on the display.

Note

For very large capacitance values, it may take several minutes for the measurement to settle and the final reading to stabilize.

5.9 Type K temperature measurements

- Set the function switch to the $\text{V}_{\text{mV}\Omega}$ position.
- Use the **MODE** button to select temperature measurement. The °F or °C unit will be displayed.
- While observing the polarity, insert the thermocouple adapter into the negative COM terminal and the positive $\text{V}_{\text{mV}\Omega}$ terminal.
- Touch the tip of the thermocouple to the part under test. Keep the thermocouple tip on the part until the reading on the display stabilizes.
- Read the temperature value on the display.

5 Operation

6. To avoid electrical shock, disconnect the thermocouple adapter before turning the function switch to another position.

5.10 Current measurements

Current is measured by disconnecting the part under test and connecting the probe leads in series with the part, see Figure 5.1.



Figure 5.1 Disconnected component

1. Set the function switch to the \tilde{A} position.
2. Insert the black probe lead into the negative COM terminal and the red probe lead into one of the following positive terminals:
 - A for high current measurements.
 - mA for low current measurements.
3. Use the **MODE** button to select AC, DC, or AC+DC voltage measurement.
 - The \sim indicator will be displayed for AC measurements.
 - The \equiv indicator will be displayed for DC measurements.
 - The $\sim \equiv$ indicator will be displayed for AC+DC measurements.
4. Connect the probe leads in series with the part in accordance with Figure 5.1.
5. Read the current value on the display.

5.11 Extended functionality

In addition to the basic measurements, the meter can be set to different modes for extended functionality.



5 Operation

5.11.1 Selecting the mode

The mode icons applicable for the selected measurement type are displayed in the lower part of the display. When a mode is enabled, the icon is framed.



Figure 5.2 Mode icons (AC voltage measurements): Peak mode and Silent mode are enabled

1. Press the ◀ or ▶ button to navigate to the desired mode icon. The currently selected icon will flash.
2. Press the  button to enable the selected (flashing) mode.
3. Press the ▲ or ▼ button to step through the mode options. Refer to the section related to the specific mode for detailed instructions.
4. Press the  button to disable the selected (flashing) mode.





5.11.2 VFD mode (ACV and ACA only)

In VFD (variable-frequency drive) mode, high-frequency noise is eliminated from the voltage measurement by a low-pass filter. VFD mode is available when measuring AC voltage or AC current.

1. Use the selector pad to select  and enable VFD mode.

5.11.3 Peak mode (ACV and ACA only)



In Peak mode, the meter captures and displays the positive and negative peak values, and updates only when a higher/lower value is registered.

1. Use the selector pad to select  and enable Peak mode.
2. Press the ▲ or ▼ button to toggle between the display of Peak Max and Peak Min.
 - In Peak Max mode, the  indicator is displayed.
 - In Peak Min mode, the  indicator is displayed.
3. Press the  button to pause the Peak mode. Press again to continue.

5 Operation

5.11.4 Min/Max/Avg mode

In Min/Max/Avg mode, the meter captures and displays the minimum or maximum values and updates only when a higher/lower value is registered. The meter also averages the total sum of all recorded values.

1. Use the selector pad to select  and enable the Min/Max/Avg mode.
2. Press the ▲ or ▼ button to cycle through the minimum, maximum, and average reading displays. The corresponding icons are displayed: ↓, ↑, or .
3. Press the  button to pause the Min/Max/Avg mode. Press again to continue.



5.11.5 Frequency mode (ACV and ACA only)

In Frequency mode, the frequency is displayed in the main display and the period is displayed in the secondary display. Frequency mode is available when measuring AC voltage or current.

1. Use the selector pad to select  and enable Frequency mode.

5.11.6 Relative mode

In Relative mode, the difference (Δ) between the current reading and a stored reference value is displayed in the main display. The reference value is displayed in the secondary display.

Use the selector pad to select  and enable Relative mode. (The reference value is stored when the  button is pressed.)

5.11.7 dBm mode (ACV only)

The decibel (dB) is a logarithmic unit that expresses the magnitude of a physical quantity relative to a specified or implied reference level. In dBm mode, the meter displays AC voltage measurements in dB or dBm on the secondary display.

dB and dBm are defined as follows:





- $\text{dB} = 20 \log (V_{AC}/1)$.
- $\text{dBm} = 20 \log (V_{AC}/0.7746)$.

5 Operation

1. Use the selector pad to select  and enable dBm mode.
2. Press the ▲ or ▼ button to toggle between the display of dB and dBm.

5.11.8 Manual Data Recording mode

The meter has 99 memory locations for the storage of measurement data.







1. Use the selector pad to select  and enable Manual Data Recording mode.
2. Press the ▲ or ▼ button to cycle through the mode options *SAVE*, *LOAD*, and *CLEAR* shown on the secondary display.
3. Press the  button to activate the displayed option:
 - *SAVE*: The data on the main display is saved to the memory location shown by the  indicator in the upper part of the display.
 - *LOAD*: The data stored in the memory location shown by the  indicator is displayed. Use the ▲ or ▼ button to change the memory location. Press the  button to exit the load function.
 - *CLEAR*: The data in all memory locations is cleared.

5.11.9 Automatic Data Recording mode

In Automatic Data Recording mode, the meter records measurement data at the user-programmed sampling rate. The recorded data can be recalled at a later time for review. Up to 20 000 records can be recorded into memory. The sampling rate can be set to a value in the range 1 to 600 seconds.

1. Use the selector pad to select  and enable Automatic Data Recording mode.
2. Press the ▲ or ▼ button to cycle through the mode options *VIEW*, *RATE*, *SEND*, and *START* shown on the secondary display.

5 Operation



3. Press the  button to activate the displayed option:
- **VIEW:** The secondary display shows the current memory location. The main display shows the data stored in the current memory location. Use the ▲ or ▼ button to change the memory location. Use the ◀ or ▶ button to change the memory location to the beginning or end. Press the  button to exit the view function.
 - **RATE:** Press the ◀ or ▶ button to change the sampling rate.
 - **SEND:** Press the  button to send the data via Bluetooth. The main display will show the percentage of data transfer (0% to 100%). At the end of the transfer the main display will show *End* (press *OK* to return to the previous screen). During data transfer, pressing the *CANCEL* button will halt the data transfer. The key pad will also be locked and only the *CANCEL* button will be active.
 - **START:** Press the  button to start the Automatic Data Recorder. Press the  button again to pause the Automatic Data Recorder. Press and hold the  button to stop the Automatic Data Recorder.

5.11.10 Setup mode

In Setup mode, you can define the settings for various meter options:

- **Auto power off** (indicated by the text *APO*): A mode where the time period after which the meter enters sleep mode can be set. The range is 1 to 30 minutes, or Off. The factory default is 10 minutes.
 - **Auto backlight off** (indicated by the text *b.Lit*): A mode where the time period after which the backlight turns off can be set. The range is 1 to 30 minutes, or Off. The factory default is 5 minutes.
 - **Continuity threshold** (indicated by the text *Cntin*): A mode where the threshold for continuity tests can be set.
 - **Auto hold** (indicated by the text *A.Hold*): A mode where auto hold mode and normal hold mode can be set. For more information about these modes, see section 5.12 *Normal hold mode and Auto hold mode*, page 24.
1. Use the selector pad to select  and enable Setup mode.
 2. Press the ▲ or ▼ button to cycle through the mode options *APO*, *b.Lit*, *Cntin*, *AHold*, and *RESET* shown on the secondary display.
-

5 Operation

3. Press the  button to activate the displayed option:
- *APO*: Press the ◀ or ▶ button to change the auto power off time.
 - *b.Lit*: Press the ◀ or ▶ button to change the auto backlight off time.
 - *Cntin*: Press the ◀ or ▶ button to change the continuity threshold.
 - *A.Hold*: Press the ◀ or ▶ button to set up auto mode and normal mode. *On* means that the hold mode is auto hold mode. *Off* means that the hold mode is normal hold mode.
 - *RESET*: Press the  button to reset the settings to the factory default.

5.11.11 Silent mode

In Silent mode, the alert beeper is disabled. Silent mode does not affect the continuity beeper.

Use the selector pad to select  and enable Silent mode.



5.12 Normal hold mode and Auto hold mode

The meter has two types of hold modes:

- Normal hold mode.
- Auto hold mode.

5.12.1 Normal hold mode

In Normal hold mode, the meter freezes and displays the last reading from the main display and continues to display this value.

To enter/exit Normal hold mode, press the  button. In Hold mode, the  indicator is displayed.



5.12.2 Auto hold mode

In Auto hold mode, the secondary display freezes the last reading from the main display and continues to display this value. The current reading is displayed on the main display. The held reading (on the secondary display) will not change unless the difference between this held reading and any new reading is greater than 50 digits.

Auto hold limit:

5 Operation

- Function switch in V position: <0.1 V.
- Function switch in LoZ position: <0.1 V.
- Function switch in mV position: <1 mV.
- Function switch in other positions: no limit.

To enter/exit Auto hold mode, press the  button. In Auto hold mode, the  indicator is displayed and flashing.

5.13 Locked mode

In Locked mode, the meter ignores all button presses except . The auto power off function, see section 5.1.1 *Auto power off*, page 14, is disabled in Locked mode.

Press and hold the  button for 3 seconds to enter/exit Locked mode.

In Locked mode, the  indicator is displayed.

5.14 Streaming measurement data using Bluetooth

5.14.1 General

Some IR cameras from FLIR Systems support Bluetooth communication, and to those cameras you can stream measurement data from the meter. The data is then merged into the result table in the IR image.

Streaming measurement data is a convenient way to add important information to an IR image. For example, when identifying an overheated cable connection, you may want to know the current in that cable.

The Bluetooth range is 10m (32ft) maximum.

5.14.2 Procedure

1. Pair the IR camera with the instrument. Refer to the camera manual for information on how to pair Bluetooth devices.
2. Turn on the camera.
3. Turn on the meter.
4. Press the  on the meter to enable Bluetooth.
5. Choose the variable that you want to use (voltage, current, resistance, etc.). Results from the meter will now automatically be displayed in the result table in the top left corner of the IR camera screen.

6 Maintenance

6.1 Cleaning and storage

Clean the meter with a damp cloth and mild detergent; do not use abrasives or solvents.

If the meter is not to be used for an extended period, remove the batteries and store them separately.

6.2 Battery replacement

1. To avoid electrical shock, disconnect the meter if connected to a circuit, remove the probe/thermocouple leads from the terminals, and set the function switch to the OFF position before attempting to replace the batteries.
2. Unscrew and remove the battery compartment cover.
3. Replace the six standard AAA batteries, observing correct polarity.
4. Secure the battery compartment cover.

6.3 Fuse replacement

The fuses are accessed via the battery compartment cover.

6.4 Disposal of electronic waste



As with most electronic products, this equipment must be disposed of in an environmentally friendly way, and in accordance with existing regulations for electronic waste.

Please contact your FLIR Systems representative for more details.

7 Technical specifications

7.1 General specifications

Maximum voltage applied to any terminal: 1000 V DC or 1000 V AC RMS.

Display count: 4000/40 000.

Polarity indication: Automatic, positive implied, negative indicated.

Over-range indication: *OL*.

Measuring rate: 10 samples per second.

Power requirements: 6 × 1.5 V AAA alkaline batteries.

Battery life: Approx. 100 hours with alkaline batteries (backlight, work light, and Bluetooth are off).

Low battery voltage: Approx. 7.0 V.

Auto power off: Default 10 minutes.

Operating ambient temperatures and relative humidity:

- -10°C to 30°C (14 °F to 86 °F), <85% RH.
- 30°C to 40°C (86 °F to 104 °F), <75% RH.
- 40°C to 50°C (104 °F to 122°F), <45% RH.

Storage temperature and relative humidity: -30°C to 60°C (-22 °F to 140 °F), 0–80% RH (batteries not fitted).

Temperature coefficient: $0.1 \times (\text{specified accuracy})/^\circ\text{C}$, <18°C, >28°C.

Operating altitude: 2000 m (6550').

Calibration cycle: once per year.

Weight: 465 g (1 lbs.) including batteries.

Dimensions (H × W × L): 52 mm × 83 mm × 188 mm (2.0" × 3.2" × 7.4") with holster.

Safety: Complies with IEC 61010-1 CAT IV-600 V, CAT III-1000 V, IEC 61010-2-033.

The Bluetooth range is 10m (32ft) maximum.

7 Technical specifications

| CAT | Application field |
|-----|---|
| I | Circuits not connected to mains |
| II | Circuits directly connected to a low-voltage installation |
| III | Building installation. |
| IV | Source of the low-voltage installation |

EMC: EN 61326-1.

Pollution degree: 2.

Shock vibration: Per MIL-PRF-28800 for a Class 2 instrument.

Drop protection: 1.5 m (5').

7.2 Electrical specifications

- Accuracy is \pm (% of reading + number of digits (dgt)) at 18–28°C (64.4–82.4°F) (<80% RH).
- For specifications in the 4 $\frac{3}{4}$ -digit mode, multiply the number of digits by 10.
- For the best measurements, use the REL Δ function to compensate for offsets.

7 Technical specifications

Table 7.1 Voltage. Resolution of specifications in the 3 ¼-digit mode.

| Mode | Range | Accuracy | | | |
|------|----------|---|----------------|------------------------|------------------------------|
| DC | 40.00 mV | 0.05%+3d | | | |
| | 400.0 mV | 0.05%+1d | | | |
| | 4.000 V | | | | |
| | 40.00 V | | | | |
| | 400.0 V | | | | |
| | 1000 V | | | | |
| | | 40 Hz to 70 Hz | 70 Hz to 1 kHz | 1 kHz to 5k Hz | 5 kHz to 20 kHz ¹ |
| AC | 40.00 mV | 0.5% + 2d | 1.0% + 4d | 2.0% + 4d | Unspecified |
| | 400.0 mV | 0.5% + 2d 1.0% + 4d 2.0% + 4d 2.0% + 20d | | | |
| | 4.000 V | | | | |
| | 40.00 V | | | | |
| | 400.0V | 0.5% + 2d | 1.0% + 4d | 2.0% + 4d ² | Unspecified |
| | 1000 V | 0.5% + 2d | 1.0% + 4d | Unspecified | Unspecified |

1. Below 10% of range, add 10d to accuracy.

2. Frequency range 1k to 2k Hz.

Input protection: 1000 V DC or 1000 V AC RMS

Input impedance:

- mV: 1 MΩ, <100 pF.
- V: 10 MΩ, <100 pF.

Bandwidth: 40 Hz to 20 kHz.

Minimum resolution: 1 μV in the 40 mV range.

CMRR/NMRR (common/normal mode rejection ratio):

7 Technical specifications

- V AC: CMRR > 60 dB at DC, 50 Hz/60 Hz.
- V DC: CMRR > 100 dB at DC, 50 Hz/60 Hz.
- NMRR > 50 dB at DC, 50 Hz/60 Hz.

AC conversion type: AC coupled, true RMS responding, calibrated to the sine wave input. For non-sine waves, add the following crest factor corrections:

- For a crest factor of 1.4–2.0, add 1.0% to the AC accuracy.
- For a crest factor of 2.0–2.5, add 2.5% to the AC accuracy.
- For a crest factor of 2.5–3.0, add 4.0% to the AC accuracy.

Table 7.2 Current. Resolution of specifications in the 3 ¼-digit mode.

| Mode | Range | Accuracy | | |
|-----------------|----------|----------------|----------------|----------------------|
| DC | 40.00 mA | 0.2%+1d | | |
| | 400.0 mA | | | |
| | 4.000 A | | | |
| | 10.00 A | 0.2%+2d | | |
| | | 40 Hz to 70 Hz | 70 Hz to 1 kHz | 1 kHz to 10 kHz |
| AC ¹ | 40.00 mA | 1.0%+2d | 2.0%+4d | 2.0%+4d ² |
| | 400.0 mA | | | |
| | 4.000 A | 1.0%+2d | 2.0%+4d | Unspecified |
| | 10.00 A | | | |

1. Below 5% of the AC range, add 20 dgt to the accuracy.

2. Below 10% of range, add 10 d to accuracy

Input protection: Equipped with a high-energy fuse.

- mA: 440 mA, 1000 V IR 10 kA fuse (Bussmann DMM-B-44/100)
- A: 11 A, 1000 V IR 20 kA fuse (Bussmann DMM-B-11A)

Input impedance:

- mA: 1 Ω at mA input.
- A: 10 mΩ at A input.

Bandwidth: 40 Hz to 10 kHz.

7 Technical specifications

Minimum resolution: 1 μ A in the 40 mA range.

Maximum measuring time: 1 minute at A input, 10 minutes at mA input. Rest time is 20 minutes minimum.

AC conversion type: The AC conversion type is the same as for the voltage.

Table 7.3 AC additional specifications

| Mode | Range | Accuracy |
|-----------|-----------------|---|
| AC+DC | Same as V and A | AC accuracy + 1.0% |
| VFD | | AC accuracy for 40–400 Hz |
| Peak hold | | AC accuracy + (3.0% + 100 dgt) for 40Hz to 1kHz |
| Low-Z | Same as V | Accuracy + 1.0% |

The cut-off frequency of VFD: 800 Hz (–3 dB point).

Attenuation characteristic of VFD: Approx. –24 dB.

Table 7.4 Frequency Counter

| Range | Resolution | Accuracy |
|------------|------------|-------------|
| 400.00 Hz | 0.01 Hz | ± 5 dgt |
| 4.0000 kHz | 0.1 Hz | |
| 40.000 kHz | 1 Hz | |
| 100.00 kHz | 10 Hz | |

Minimum sensed frequency: 5 Hz.

7 Technical specifications

Table 7.5 Frequency counter sensitivity

| Function | Range | Sensitivity (peak to peak) 5 Hz to 10 kHz | Sensitivity (peak to peak) 10–100 kHz |
|----------|-----------|---|---|
| mV | 40.000 mV | 10 mV | 10 mV |
| | 400.00 mV | 100 mV | 100 mV |
| V | 4.0000 V | 1 V | 1 V |
| | 40.000 V | 10 V | 10 V |
| | 400.00 V | 100 V | 100 V |
| | 1000 V | 600 V | Unspecified |
| mA | 40.000 mA | 10 mA | Unspecified |
| | 400.00 mA | 100 mA | |
| A | 4.0000 A | 1 A | Unspecified |
| | 10.000 A | 6 A | |

Table 7.6 Resistance. Resolution of specifications in the 3 ¼-digit mode.

| Range | Resolution | Accuracy |
|----------|------------|------------------|
| 400.0 Ω | 100 mΩ | ±(0.2% + 2 dgt) |
| 4.000 kΩ | 1 Ω | ±(0.2% + 1 dgt) |
| 40.00 kΩ | 10 Ω | |
| 400.0 kΩ | 100 Ω | |
| 4.000 MΩ | 1 kΩ | ±(1.0% + 1 dgt) |
| 40.00 MΩ | 10 kΩ | ±(2.0% + 20 dgt) |

Input protection: 1000 V DC or 1000 V AC RMS.

Maximum open circuit voltage: Approx. 2.5 V.

Maximum short test current: Approx. 0.1 mA.

7 Technical specifications

Table 7.7 Continuity check. Resolution of specifications in the 3 ¼-digit mode.

| Range | Resolution | Accuracy |
|---------|------------|-----------------|
| 400.0 Ω | 100 mΩ | ±(0.2% + 2 dgt) |

Input protection: 1000 V DC or 1000 V AC RMS.

Maximum open circuit voltage: Approx. 2.5 V.

Maximum short test current: Approx. 1 mA.

Continuity threshold: Default <30 Ω.

Continuity response time: 10 ms for <10 Ω, 200 ms for >10 Ω.

Continuity indicator: 2 kHz tone buzzer.

Table 7.8 Diode test

| Range | Resolution | Accuracy |
|-------|------------|-----------------|
| 2.000 | 1 mV | ±(1.5% + 2 dgt) |

Input protection: 1000 V DC or 1000 V AC RMS.

Maximum open circuit voltage: Approx. ±2.5 V.

Maximum short test current: Approx. ±1 mA.

Table 7.9 Capacitance

| Range | Resolution | Accuracy |
|----------|------------|------------------|
| 40.00 nF | 10 pF | ±(1.2% + 20 dgt) |
| 400.0 nF | 100 pF | ±(0.9% + 2 dgt) |
| 4.000 μF | 1 nF | |
| 40.00 μF | 10 nF | |
| 400.0 μF | 100 nF | ±(1.2% + 20 dgt) |
| 4.000 mF | 1 μF | |
| 40.00 mF | 10 μF | ±(2.0% + 20 dgt) |

7 Technical specifications

Input protection: 1000 V DC or 1000 V AC RMS.

Table 7.10 Temperature

| Range | Resolution | Accuracy |
|------------------|------------|------------|
| -328°F to 2192°F | 0.1°F | 1.0% + 36d |
| -200°C to 1200°C | 0.1°C | 1.0% + 20d |

Input protection: 1000 V DC or 1000 V AC RMS.

Note

Accuracy specification assumes the ambient temperature is stable to $\pm 1^{\circ}\text{C}$ ($\pm 1.8^{\circ}\text{F}$). For ambient temperature changes of $\pm 5^{\circ}\text{C}$ ($\pm 9^{\circ}\text{F}$), the rated accuracy applies after 1 hour.

8 Technical support

| | |
|-------------------|--|
| Website | http://www.flir.com/test |
| Technical support | T&MSupport@flir.com |
| Repairs | Repair@flir.com |
| Phone number | +1 855-499-3662 (toll-free) |

9 Warranties

9.1 FLIR Global Limited Lifetime Warranty

A qualifying FLIR Test and Measurement product (the "Product") purchased either directly from FLIR Commercial Systems Inc and affiliates (FLIR) or from an authorized FLIR distributor or reseller that Purchaser registers on-line with FLIR is eligible for coverage under FLIR's Limited Lifetime Warranty, subject to the terms and conditions in this document. This warranty only applies to purchases of Qualifying Products (see below) purchased and manufactured after April 1, 2013.

PLEASE READ THIS DOCUMENT CAREFULLY; IT CONTAINS IMPORTANT INFORMATION ABOUT THE PRODUCTS THAT QUALIFY FOR COVERAGE UNDER THE LIMITED LIFETIME WARRANTY, PURCHASER'S OBLIGATIONS, HOW TO ACTIVATE THE WARRANTY, WARRANTY COVERAGE, AND OTHER IMPORTANT TERMS, CONDITIONS, EXCLUSIONS AND DISCLAIMERS.

1. PRODUCT REGISTRATION. To qualify for FLIR's Limited Lifetime Warranty, Purchaser must fully register the Product directly with FLIR on-line at <http://www.flir.com> within Sixty (60) DAYS of the date the Product was purchased by the first retail customer (the "Purchase Date"). Qualifying PRODUCTS THAT ARE NOT REGISTERED ON-LINE WITHIN SIXTY (60) DAYS OF THE PURCHASE DATE WILL HAVE A LIMITED ONE YEAR WARRANTY FROM DATE OF PURCHASE.

2. QUALIFYING PRODUCTS. Upon registration, Test and Measurement products that qualify for coverage under FLIR's Limited Lifetime Warranty are: MR7x, CM7x, CM8x, DMxx, VP5x not including accessories which may have their own warranty.

3. WARRANTY PERIODS. For purposes of the The Limited Lifetime Warranty, Lifetime is defined as seven years (7) after the product is no longer manufactured, or ten years (10) from date of purchase, whichever is greater. This Warranty is only applicable to the original owner of the Products.

Any Product that is repaired or replaced under warranty is covered under this Limited Lifetime Warranty for one hundred eighty days (180) days from the date of return shipment by FLIR or for the remaining duration of the applicable Warranty Period, whichever is longer.

4. LIMITED WARRANTY. In accordance with the terms and conditions of this Limited Lifetime Warranty, and except as excluded or disclaimed in this document, FLIR warrants, from the Purchase Date, that all fully registered Products will conform to FLIR's published Product specifications and be free from defects in materials and workmanship during the applicable Warranty Period. PURCHASER'S SOLE AND EXCLUSIVE REMEDY UNDER THIS WARRANTY, AT FLIR'S SOLE DISCRETION, IS THE REPAIR OR REPLACEMENT OF

DEFECTIVE PRODUCTS IN A MANNER, AND BY A SERVICE CENTER, AUTHORIZED BY FLIR. IF THIS REMEDY IS ADJUDICATED TO BE INSUFFICIENT, FLIR SHALL REFUND PURCHASER'S PAID PURCHASE PRICE AND HAVE NO OTHER OBLIGATION OR LIABILITY TO BUYER WHATSOEVER.

5. WARRANTY EXCLUSIONS AND DISCLAIMERS. FLIR MAKES NO OTHER WARRANTY OF ANY KIND WITH RESPECT TO THE PRODUCTS. ALL OTHER WARRANTIES, EXPRESS OR IMPLIED, INCLUDING BUT NOT LIMITED TO IMPLIED WARRANTIES OF MERCHANTABILITY, FITNESS FOR A PARTICULAR PURPOSE (EVEN IF PURCHASER HAS NOTIFIED FLIR OF ITS INTENDED USE FOR THE PRODUCTS), AND NON-INFRINGEMENT ARE EXPRESSLY EXCLUDED FROM THIS AGREEMENT.

THIS WARRANTY EXPRESSLY EXCLUDES ROUTINE PRODUCT MAINTENANCE, SOFTWARE UPDATES, AND REPLACEMENT OF MANUALS, FUSES, OR DISPOSABLE BATTERIES. FLIR FURTHER EXPRESSLY DISCLAIMS ANY WARRANTY COVERAGE WHERE THE ALLEGED NONCONFORMITY IS DUE TO NORMAL WEAR AND TEAR, OTHER ALTERATION, MODIFICATION, REPAIR, ATTEMPTED REPAIR, IMPROPER USE, IMPROPER MAINTENANCE, NEGLIGENCE, ABUSE, IMPROPER STORAGE, FAILURE TO FOLLOW ANY PRODUCT INSTRUCTIONS, DAMAGE (WHETHER CAUSED BY ACCIDENT OR OTHERWISE), OR ANY OTHER IMPROPER CARE OR HANDLING OF THE PRODUCTS CAUSED BY ANYONE OTHER THAN FLIR OR FLIR'S EXPRESSLY AUTHORIZED DESIGNEE.

THIS DOCUMENT CONTAINS THE ENTIRE WARRANTY AGREEMENT BETWEEN PURCHASER AND FLIR AND SUPERSEDES ALL PRIOR WARRANTY NEGOTIATIONS, AGREEMENTS, PROMISES AND UNDERSTANDINGS BETWEEN PURCHASER AND FLIR. THIS WARRANTY MAY NOT BE ALTERED WITHOUT THE EXPRESS WRITTEN CONSENT OF FLIR.

6. WARRANTY RETURN, REPAIR AND REPLACEMENT. To be eligible for warranty repair or replacement, Purchaser must notify FLIR within thirty (30) days of discovering of any apparent defect in materials or workmanship. Before Purchaser may return a Product for warranty service or repair, Purchaser must first obtain a returned material authorization (RMA) number from FLIR. To obtain the RMA number Owner must provide an original proof of purchase. For additional information, to notify FLIR of an apparent defect in materials or workmanship, or to request an RMA number, visit <http://www.flir.com>. Purchaser is solely responsible for complying with all RMA instructions provided by FLIR including but not limited to adequately packaging the Product for shipment to FLIR and for all packaging and shipping costs. FLIR will pay for returning to Purchaser any Product that FLIR repairs or replaces under warranty.

9 Warranties

FLIR reserves the right to determine, in its sole discretion, whether a returned Product is covered under Warranty. If FLIR determines that any returned Product is not covered under Warranty or is otherwise excluded from Warranty coverage, FLIR may charge Purchaser a reasonable handling fee and return the Product to Purchaser, at Purchaser's expense, or offer Purchaser the option of handling the Product as a non-warranty return.

7. NON-WARRANTY RETURN. Purchaser may request that FLIR evaluate and service or repair a Product not covered under warranty, which FLIR may agree to do in its sole discretion. Before Purchaser returns a Product for non-warranty evaluation and repair, Purchaser must contact FLIR by visiting <http://www.flir.com> to request an evaluation and obtain an RMA. Purchaser is solely responsible for complying with all RMA instructions provided by FLIR including but not limited to adequately packaging the Product for shipment to FLIR and for all packaging and shipping costs. Upon receipt of an authorized non-warranty return, FLIR will evaluate the Product and contact Purchaser regarding the feasibility of and the costs and fees associated with Purchaser's request. Purchaser shall be responsible for the reasonable cost of FLIR's evaluation, for the cost of any repairs or services authorized by Purchaser, and for the cost of repackaging and returning the Product to Purchaser.

Any non-warranty repair of a Product is warranted for one hundred eighty days (180) days from the date of return shipment by FLIR to be free from defects in materials and workmanship only, subject to all of the limitations, exclusions and disclaimers in this document.

9.2 FLIR Test and Measurement Limited 2 Year Warranty

A qualifying FLIR Test and Measurement product (the "Product") purchased either directly from FLIR Commercial Systems Inc and affiliates (FLIR) or from an authorized FLIR distributor or reseller that Purchaser registers on-line with FLIR is eligible for coverage under FLIR's Limited Warranty, subject to the terms and conditions in this document. This warranty only applies to purchases of Qualifying Products (see below) purchased and manufactured after April 1, 2013.

PLEASE READ THIS DOCUMENT CAREFULLY; IT CONTAINS IMPORTANT INFORMATION ABOUT THE PRODUCTS THAT QUALIFY FOR COVERAGE UNDER THE LIMITED WARRANTY, PURCHASER'S OBLIGATIONS, HOW TO ACTIVATE THE WARRANTY, WARRANTY COVERAGE, AND OTHER IMPORTANT TERMS, CONDITIONS, EXCLUSIONS AND DISCLAIMERS.

1. PRODUCT REGISTRATION. To qualify for FLIR's Limited Warranty, Purchaser must fully register the Product directly with FLIR on-line at <http://www.flir.com> within Sixty (60) DAYS of the date the Product was purchased by the first retail customer (the "Purchase Date"). Qualifying PRODUCTS THAT ARE NOT REGISTERED ON-LINE

WITHIN SIXTY (60) DAYS OF THE PURCHASE DATE WILL HAVE A LIMITED ONE YEAR WARRANTY FROM DATE OF PURCHASE.

2. QUALIFYING PRODUCTS. Upon registration, Test and Measurement products that qualify for coverage under FLIR's Limited Warranty are: VS70 Videoscope, VSAxx Articulation Camera, VSCxx Camera, VSSxx Probe Spool, VST handset, MR02 Pin Extension Probe, and TAxX not including accessories which may have their own warranty.

3. WARRANTY PERIODS. The applicable Limited Warranty Period measured from the Purchase data are:

| Products | Limited Warranty Period |
|--|-------------------------|
| VS70, VSAxx, VSCxx, VSSxx, VST, MR02, TAxX | TWO (2) Years |

Any Product that is repaired or replaced under warranty is covered under this Limited Warranty for one hundred eighty days (180) days from the date of return shipment by FLIR or for the remaining duration of the applicable Warranty Period, whichever is longer.

4. LIMITED WARRANTY. In accordance with the terms and conditions of this Limited Warranty, and except as excluded or disclaimed in this document, FLIR warrants, from the Purchase Date, that all fully registered Products will conform to FLIR's published product specifications and be free from defects in materials and workmanship during the applicable Warranty Period. PURCHASER'S SOLE AND EXCLUSIVE REMEDY UNDER THIS WARRANTY, AT FLIR'S SOLE DISCRETION, IS THE REPAIR OR REPLACEMENT OF DEFECTIVE PRODUCTS IN A MANNER, AND BY A SERVICE CENTER, AUTHORIZED BY FLIR. IF THIS REMEDY IS ADJUDICATED TO BE INSUFFICIENT, FLIR SHALL REFUND PURCHASER'S PAID PURCHASE PRICE AND HAVE NO OTHER OBLIGATION OR LIABILITY TO BUYER WHATSOEVER.

5. WARRANTY EXCLUSIONS AND DISCLAIMERS. FLIR MAKES NO OTHER WARRANTY OF ANY KIND WITH RESPECT TO THE PRODUCTS. ALL OTHER WARRANTIES, EXPRESS OR IMPLIED, INCLUDING BUT NOT LIMITED TO IMPLIED WARRANTIES OF MERCHANTABILITY, FITNESS FOR A PARTICULAR PURPOSE (EVEN IF PURCHASER HAS NOTIFIED FLIR OF ITS INTENDED USE FOR THE PRODUCTS), AND NON-INFRINGEMENT ARE EXPRESSLY EXCLUDED FROM THIS AGREEMENT.

THIS WARRANTY EXPRESSLY EXCLUDES ROUTINE PRODUCT MAINTENANCE, SOFTWARE UPDATES, AND REPLACEMENT OF FUSES, OR DISPOSABLE BATTERIES. FLIR FURTHER EXPRESSLY DISCLAIMS ANY WARRANTY COVERAGE WHERE THE ALLEGED NONCONFORMITY IS DUE TO NORMAL WEAR AND TEAR, OTHER ALTERATION, MODIFICATION, REPAIR, ATTEMPTED REPAIR, IMPROPER USE, IMPROPER

9 Warranties

MAINTENANCE, NEGLIGENCE, ABUSE, IMPROPER STORAGE, FAILURE TO FOLLOW ANY PRODUCT INSTRUCTIONS, DAMAGE (WHETHER CAUSED BY ACCIDENT OR OTHERWISE), OR ANY OTHER IMPROPER CARE OR HANDLING OF THE PRODUCTS CAUSED BY ANYONE OTHER THAN FLIR OR FLIR'S EXPRESSLY AUTHORIZED DESIGNEE.

THIS DOCUMENT CONTAINS THE ENTIRE WARRANTY AGREEMENT BETWEEN PURCHASER AND FLIR AND SUPERSEDES ALL PRIOR WARRANTY NEGOTIATIONS, AGREEMENTS, PROMISES AND UNDERSTANDINGS BETWEEN PURCHASER AND FLIR. THIS WARRANTY MAY NOT BE ALTERED WITHOUT THE EXPRESS WRITTEN CONSENT OF FLIR.

6. WARRANTY RETURN, REPAIR AND REPLACEMENT.

To be eligible for warranty repair or replacement, Purchaser must notify FLIR within thirty (30) days of discovering of any apparent defect in materials or workmanship. Before Purchaser may return a Product for warranty service or repair, Purchaser must first obtain a returned material authorization (RMA) number from FLIR. To obtain the RMA number Owner must provide an original proof of purchase. For additional information, to notify FLIR of an apparent defect in materials or workmanship, or to request an RMA number, visit <http://www.flir.com>. Purchaser is solely responsible for complying with all RMA instructions provided by FLIR including but not limited to adequately packaging the Product for shipment to FLIR and for all packaging and shipping costs. FLIR will pay for returning to Purchaser any Product that FLIR repairs or replaces under warranty.

FLIR reserves the right to determine, in its sole discretion, whether a returned Product is covered under Warranty. If FLIR determines that any returned Product is not covered under Warranty or is otherwise excluded from Warranty coverage, FLIR may charge Purchaser a reasonable handling fee and return the Product to Purchaser, at Purchaser's expense, or offer Purchaser the option of handling the Product as a non-warranty return.

7. NON-WARRANTY RETURN. Purchaser may request that FLIR evaluate and service or repair a Product not covered under warranty, which FLIR may agree to do in its sole discretion. Before Purchaser returns a Product for non-warranty evaluation and repair, Purchaser must contact FLIR by visiting <http://www.flir.com> to request an evaluation and obtain an RMA. Purchaser is solely responsible for complying with all RMA instructions provided by FLIR including but not limited to adequately packaging the Product for shipment to FLIR and for all packaging and shipping costs. Upon receipt of an authorized non-warranty return, FLIR will evaluate the Product and contact Purchaser regarding the feasibility of and the costs and fees associated with Purchaser's request. Purchaser shall be responsible for the reasonable cost of FLIR's evaluation, for the cost of any repairs or services authorized by Purchaser, and for the cost of repackaging and returning the Product to Purchaser.

Any non-warranty repair of a Product is warranted for one hundred eighty days (180) days from the date of return shipment by FLIR to be free from defects in materials and workmanship only, subject to all of the limitations, exclusions and disclaimers in this document.

A note on the technical production of this publication

This publication was produced using XML — the eXtensible Markup Language. For more information about XML, please visit <http://www.w3.org/XML/>

A note on the typeface used in this publication

This publication was typeset using Linotype Helvetica™ World. Helvetica™ was designed by Max Miedinger (1910–1980)

LOEF (List Of Effective Files)

T501024.xml; en-US; AH; 9541; 2013-10-31



Corporate Headquarters

FLIR Systems, Inc.
27700 SW Parkway Ave.
Wilsonville, OR 97070
USA
Telephone: +1-503-498-3547

Website

<http://www.flir.com>

Customer support

<http://support.flir.com>

Publ. No.: T559824
Release: AH
Commit: 9541
Head: 9541
Language: en-US
Modified: 2013-10-31
Formatted: 2013-10-31



T559824